



Installation Guide

TVS 2300

RAM 1500 HEMI 5.7L V8 with eTorque



RAM HEMI 5.7L WITH ETORQUE SUPERCHARGER

Installation Guide



The Harrop TVS2300 Supercharger Tuner kit has been developed for RAM Hemi 5.7L V8 engines with eTorque mild hybrid technology. The kit was developed on a RAM 1500 with RHD conversion. LHD vehicles may require modifications to the installation.

Harrop Part Number	RAM HEMI 5.7L V8 with eTorque
99-KSM79K56	FDI2300 Supercharger kit – RAM 1500 with eTorque



Note that this is a Tuner kit; a full kit will be available once an Executive Order (EO) number from CARB has been obtained. For off-road use only in North America without EO number.



Contents

Vehicle Preparation.....	3
1) ECU Identification and Preparation	4
2) Install Intercooler Radiator and Pump.....	5
3) Remove RAM Inlet Manifold and eTorque motor.....	11
4) Install Harrop Supercharger Manifold	15
5) Install Ancillary hoses	17
6) Wiring.....	18
7) Plumbing the intercooler.....	18
8) Install Supercharger Head Unit and Intake.....	19
9) Install PCV housing	21
10) Install eTorque motor	21
11) Finalise Installation	24
12) Initial engine start and Calibration	24
13) Service considerations	24

Vehicle Preparation

Throughout this guide, RHS of vehicle is from the driver’s perspective when in the driving position.

- Ensure the fuel tank contains 98-RON (93-AKI) fuel.
- Allow the engine to cool before starting installation.
- Disconnect the battery. During installation the eTorque motor will be temporarily removed.
- Remove the front under tray.

1) ECU Identification and Preparation

Before commencing installation, the ECU must be checked to ensure it is able to be access via HP Tuners for tuning. 2023 RAM 1500 E-Torque has introduced a new ECU which is currently unable to be accessed for tuning via HP Tuners thus unable to have our E-Torque TVS2300 kit installed.

2023+ RAM E-Torque – Plugs on top of ECU – Unable to access for tuning (currently no ETA on access).

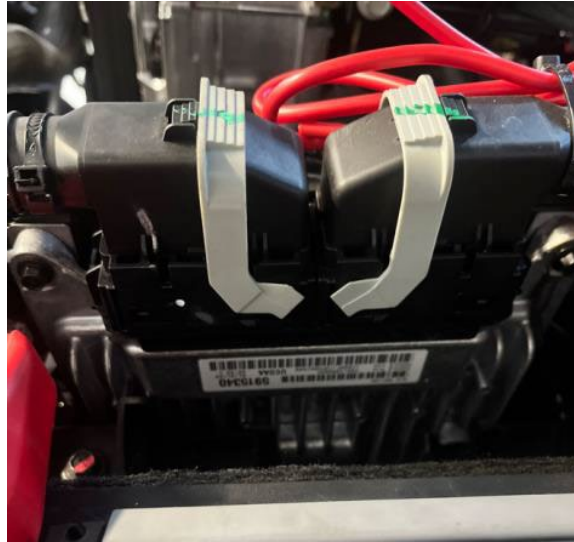

Pre 2023 RAM E-Torque – Plugs on face of ECU – Can be accessed for tuning.



The following process must be completed in order to gain access to the tuneable ECU:

- a. Install a smart access cable to the vehicle, available at:
<https://www.hptuners.com/product/dodge-2018-smart-access-cable/>
- b. Read and save the original file from the ECU using HP Tuners software
- c. Send the Vehicle's ECU to HP Tuners for modification. Refer to:
<https://www.hptuners.com/product/pcm-modification-service/>
- d. Once the ECU has been modified and returned, re-install it to the vehicle and commence the Supercharger installation.

2) Install Intercooler Radiator and Pump

- a. Remove black Radiator panel cover – 12 push pin clips.
- b. Remove 8 black bolts and 2 clips and remove trim panel.



- c. If vehicle is fitted with fender flares, these will need to be removed to remove the grill.
- d. Remove the fascia pieces from under the headlights
- e. Remove the 12 bolts (6 each side) from the front of the grill and the 4 bolts from the top of the grill.



- f. Unclip the camera harness if fitted and remove the grill.
- g. Remove the 4 bolts holding the active grill shutter and remove the active grill shutter.

RAM HEMI 5.7L WITH ETORQUE SUPERCHARGER



Installation Guide

If the vehicle has a Black A/C Condenser, follow steps h) to i) below. 3x Intercooler Radiator brackets are not used.

If the vehicle has a silver A/C Condenser, follow steps j) to n) below. Temporarily remove the washer bottle reservoir to gain access.

- h. Remove 6x 10mm bolts that retain air conditioning condenser and slip the Intercooler between the Radiator support and Air-conditioning condenser. Resecure intercooler and air conditioning condenser with the bolts that were removed.

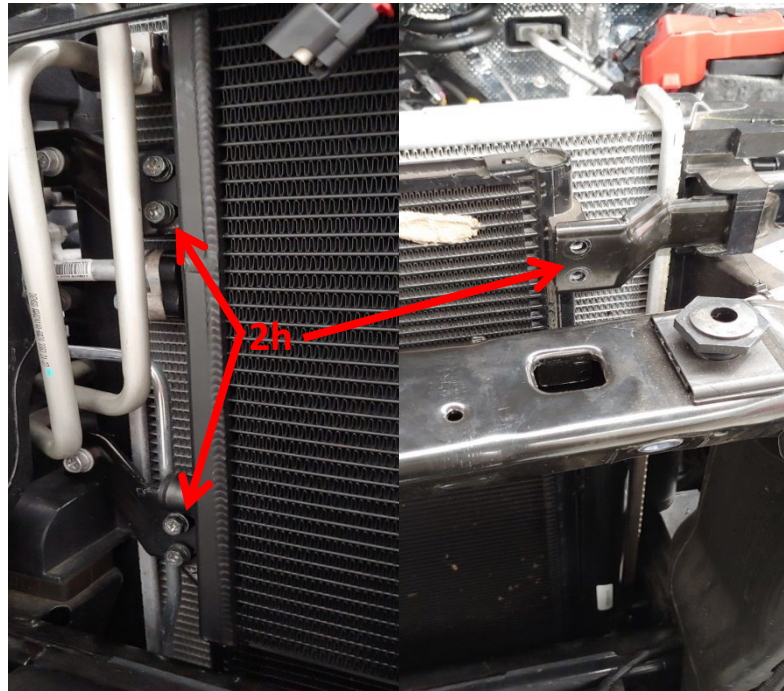

- i. Secure bottom LH corner of intercooler using supplied bracket, 14562, and supplied fasteners to attach to the supercooling bottle of the air conditioning system. Use a small amount of silicone to secure bracket to bottle before tightening fasteners.

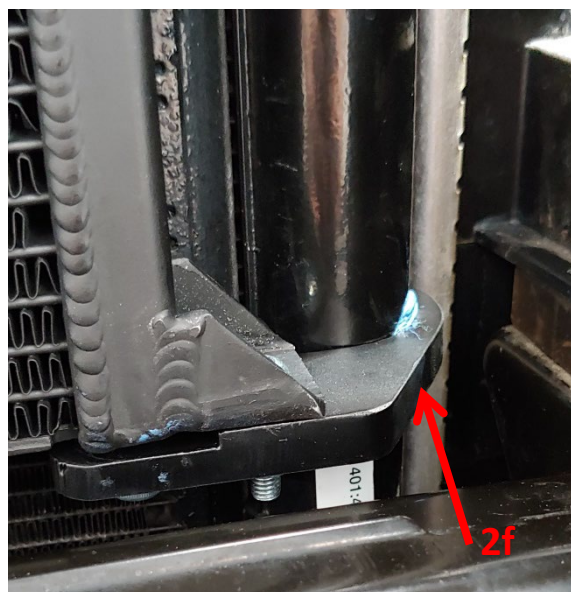

- j. On the RHS of the A/C Condenser, attach the 2x supplied Radiator brackets using the original A/C Condenser mount bolts.
- k. On the top LHS of the supplied Intercooler Radiator, attach the supplied hook bracket using the supplied M6x20 flanged bolts and M6 flanged nuts.

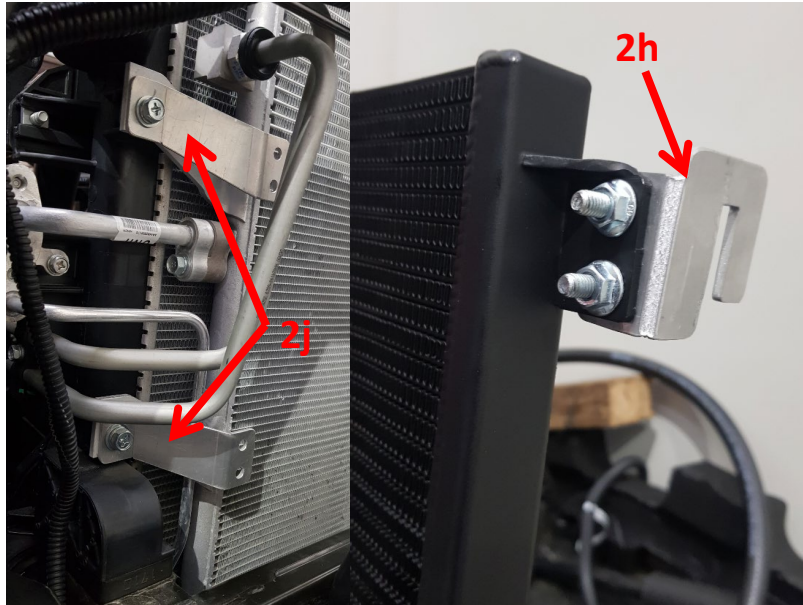

- l. Install the radiator from the top down and hook the LHS bracket over the A/C Condenser bracket.
- m. On the RHS, use the supplied M6x20 flanged bolts and M6 flanged nuts to secure the Intercooler Radiator to the top and bottom mounting brackets installed in step 2j.

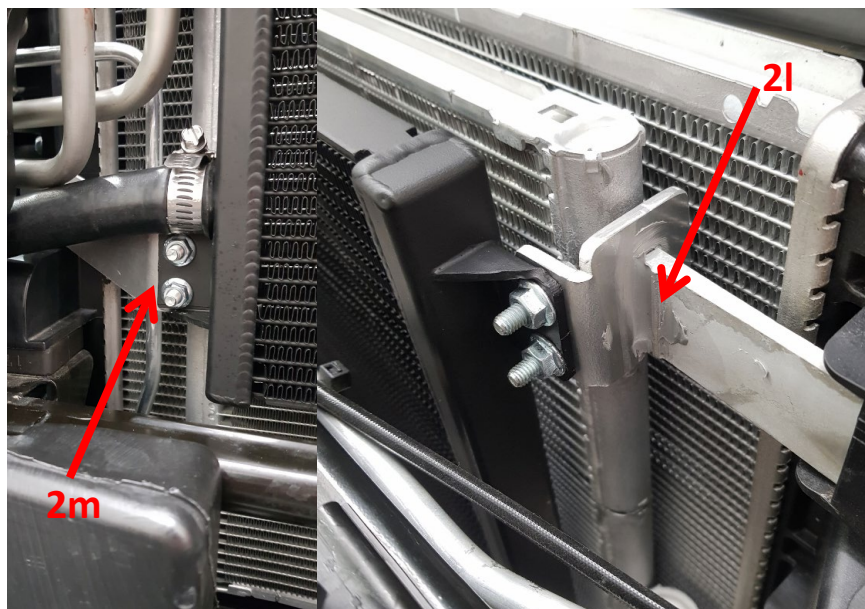

- n. Secure bottom right hand corner of intercooler using supplied bracket, 14562, and supplied M6x16 bolt, M6x25 bolt, M6 washers and M6 nyloc nut to attach to the supercooling bottle of the air conditioning system. Use a small amount of silicone to secure bracket to bottle before tightening fasteners.

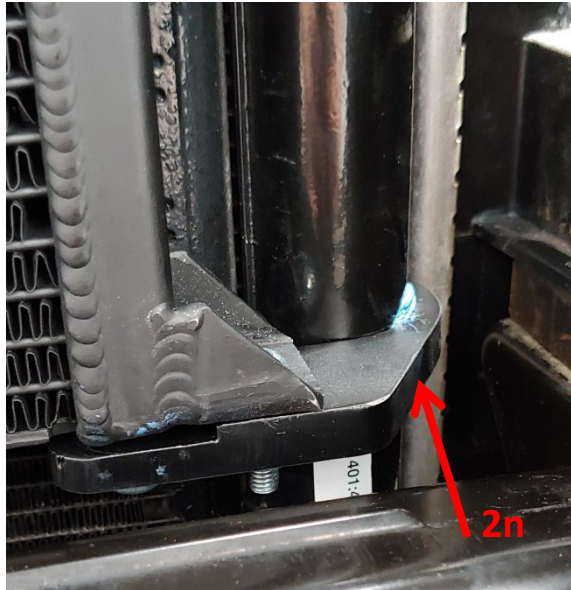

- o. At the RH inner guard behind the airbox, remove 2X M6 nuts from the earth tags and replace with 2x supplied M6 flange nuts.
- p. Attach intercooler coolant reservoir, A15534, to the two M6 studs on the RH inner guard and re-install the 2x OE M6 nuts.

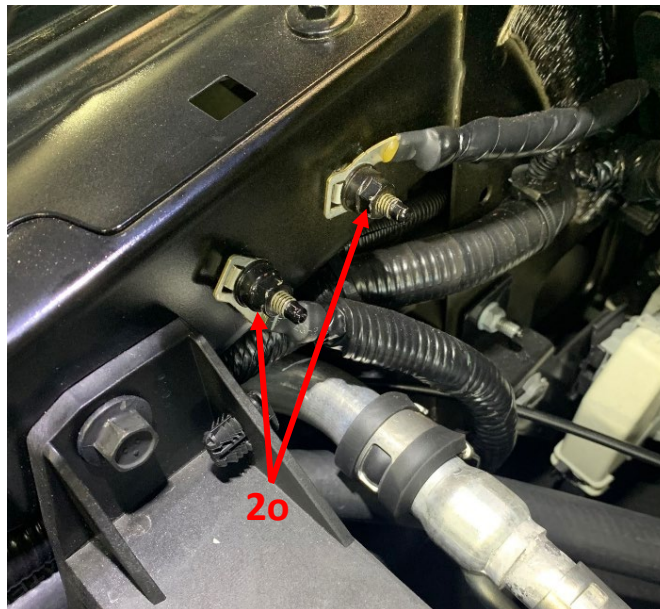

RAM HEMI 5.7L WITH ETORQUE SUPERCHARGER



Installation Guide

- q. Adjacent to the lower radiator hose, loosen 2x existing flange head screws and install the supplied 12mm OD spacer onto the sensor stud.
- r. Install the intercooler bracket #15544. Re-tighten the flange head screws and fasten the supplied M6 flange nut to secure the bracket. Bolt the pump assembly to the bracket using the supplied screws.

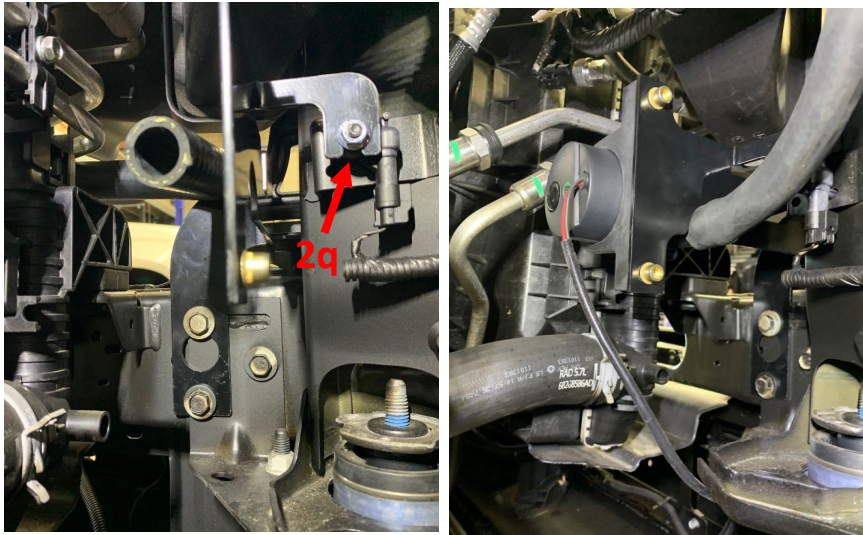

- s. Secure the Intercooler Pump relay to the outside of the Fuse-box using the supplied M6x12 button head bolt, M6 washer and M6 nyloc nut.
- t. Connect the Red wire to the second 12V+ Terminal at the fuse box
- u. Connect the Black wire to Vehicle Earth.
- v. Run the Fuse break-out lead inside the fuse box. Remove fuse #F59 (INJ/IGN COIL/ GLO PLUG MOD) 25A and plug the fuse break-out in its place. Ensure that the bottom fuse is a 25A.
- w. Make a small notch in the corner of the fuse-box to allow the break-out lead to pass through.

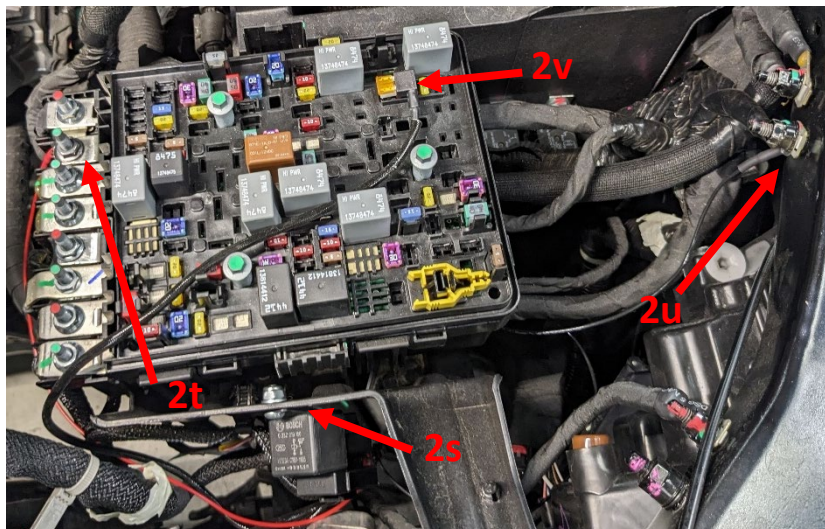

RAM HEMI 5.7L WITH ETORQUE SUPERCHARGER



Installation Guide

- x. Cable-tie the Pump lead to the A/C condenser hard-line, then run the loom across the top of the engine radiator and down to the pump.
- y. Plug the Pump lead into the Pump and cable tie to the A/C hard-line.

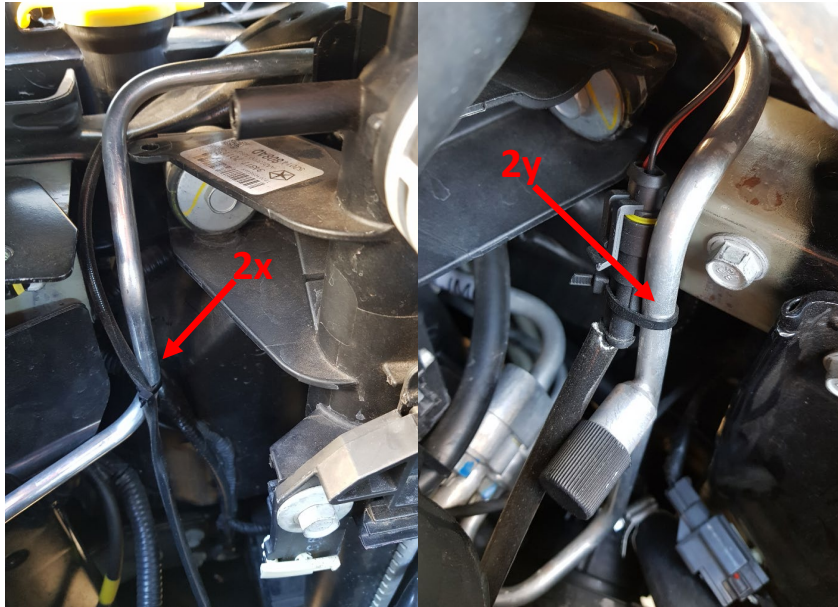

3) Remove RAM Inlet Manifold and eTorque motor

- Disconnect IAT and throttle loom plug.
- Remove engine cover.
- Remove PCV Breather hose between inlet tube and oil filler tube.
- Remove inlet tube.

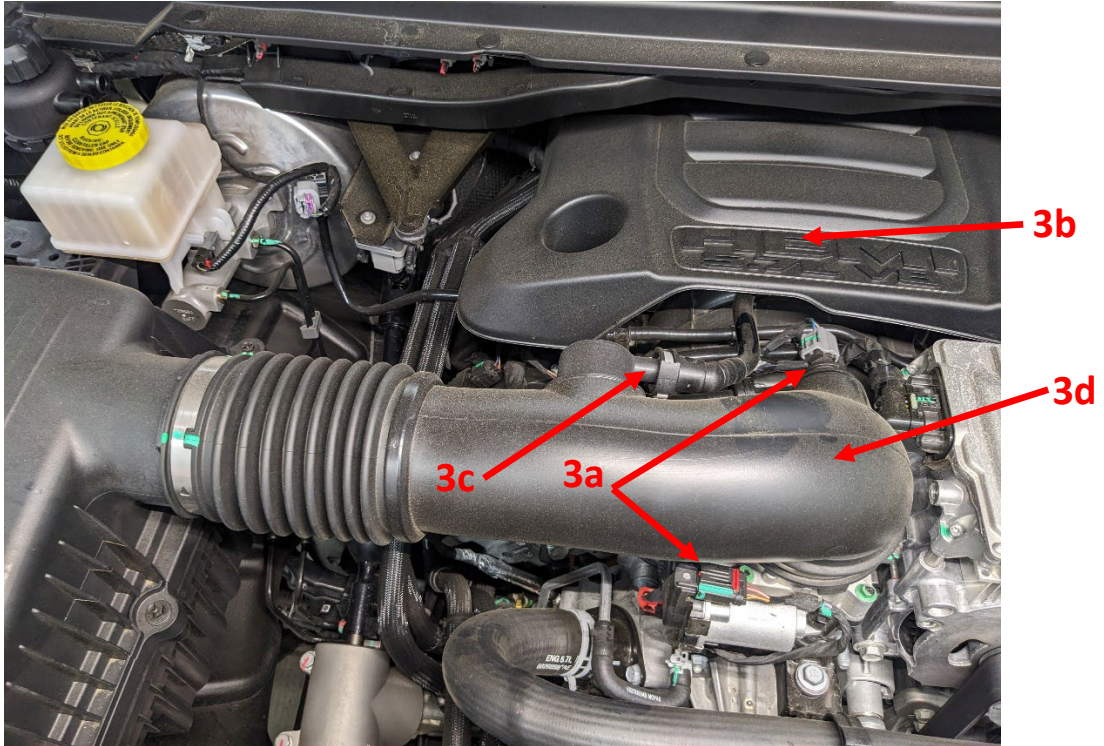

RAM HEMI 5.7L WITH ETORQUE SUPERCHARGER



Installation Guide

- e. Unclip the radiator hose and AC line from the front bracket
- f. Remove the Fuel purge solenoid from the manifold.

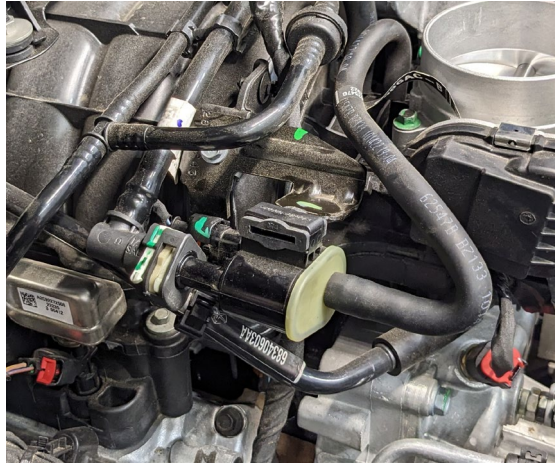

- g. Remove the loom clip from the coolant temp sensor in the thermostat housing.
- h. Disconnect the brake booster hose from the inlet manifold and the vacuum pump.
- i. Disconnect the fuel purge line from the hard line on the RHS.
- j. Remove eTorque power wire bracket by undoing the 4 nuts securing it.
- k. Disconnect eTorque power wire from the eTorque motor following Dodge guidelines.

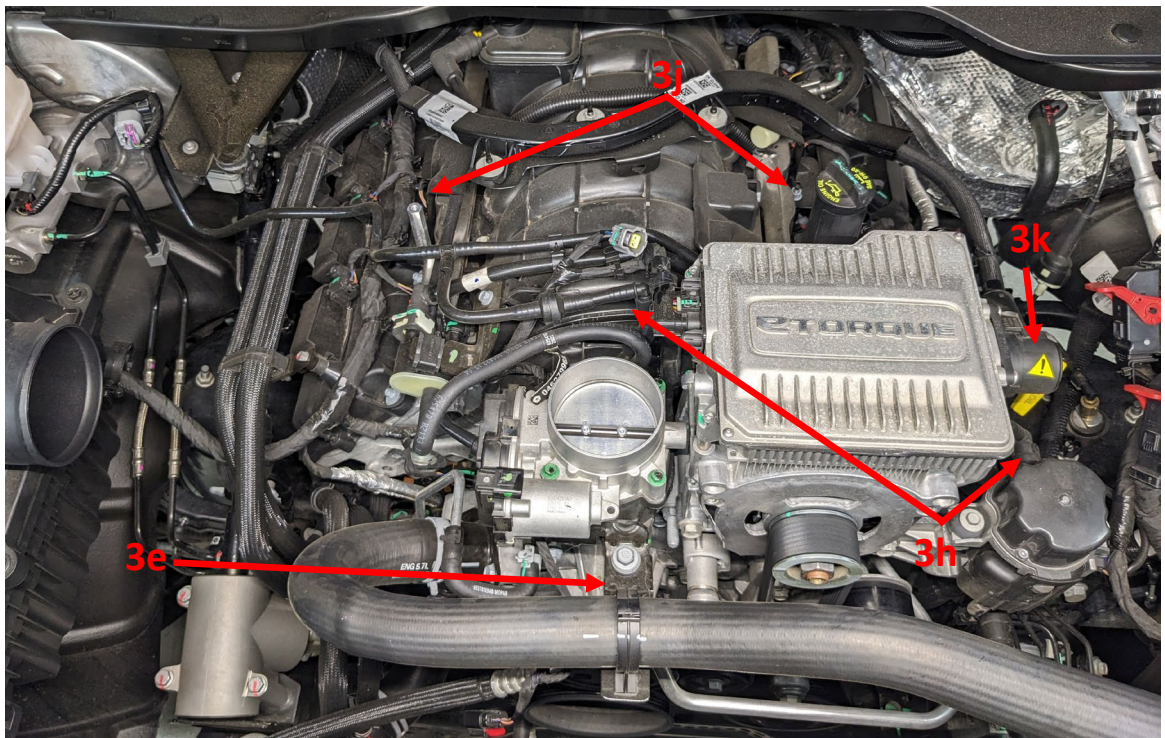

RAM HEMI 5.7L WITH ETORQUE SUPERCHARGER



Installation Guide

- l. Unplug 8x Injectors.
- m. Unplug MAP sensor at the RH rear of the manifold.
- n. Disconnect the fuel inlet from the LHS fuel rail.

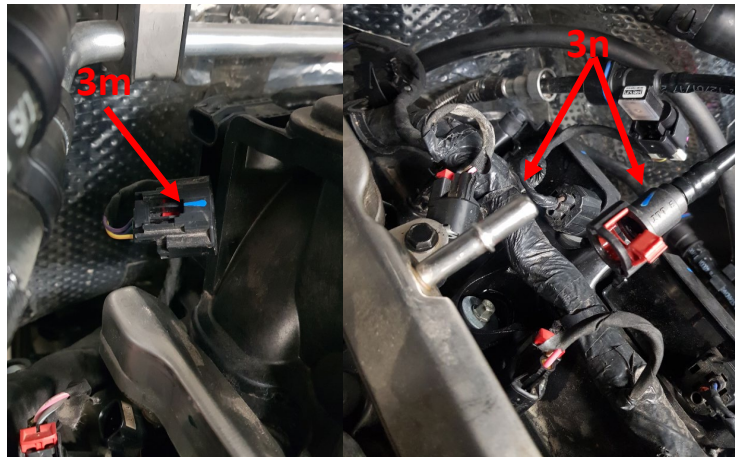

- o. Remove the water pump belt from the engine.
- p. Undo the 2 bolts and remove the lower belt tensioner stopper.

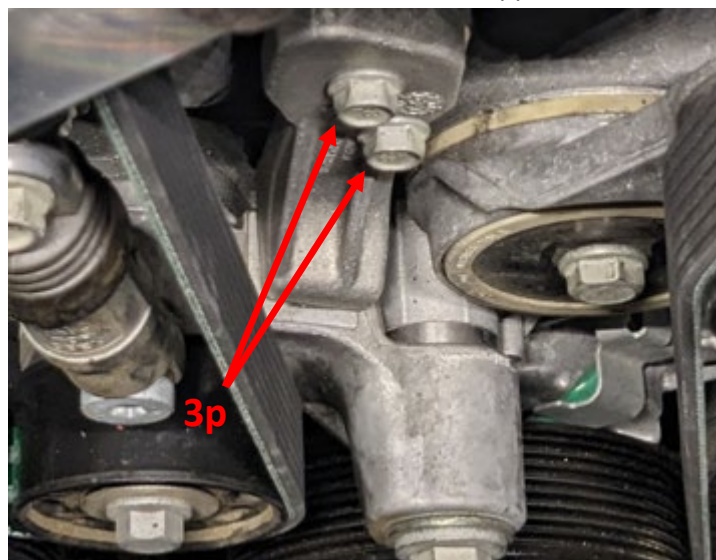

- q. Remove FEAD belt from the engine. The lower tensioner has a 1/2" square drive underneath the pulley to fit a breaker bar with an extension.

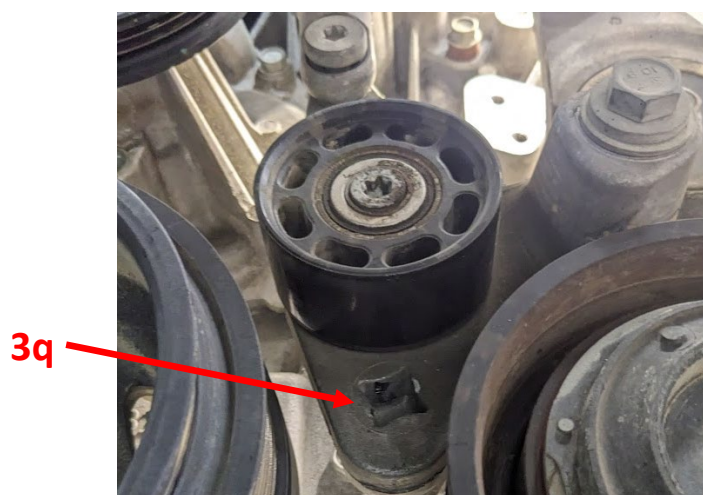

- r. Remove the top belt tensioner.
- s. Earlier trucks have this bar that bolts to the eTorque motor and a bracket over the rocker cover. This needs to be removed and will not be reinstalled.

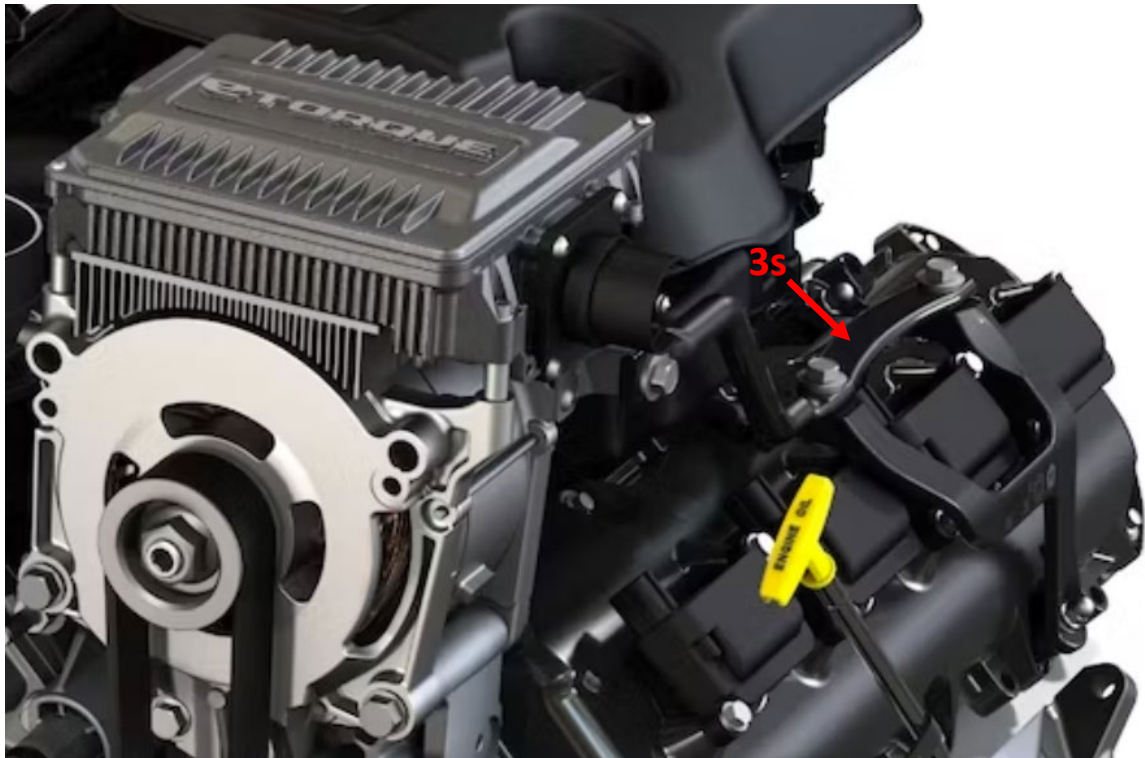

- t. Remove the 5 bolts holding the eTorque motor and remove the eTorque motor. When removing the long bolts, undo them most of the way then lightly tap on the heads with a hammer to push the slide nuts out the back of the eTorque motor.
- u. Remove the auxiliary eTorque motor bracket. This will not be reinstalled.

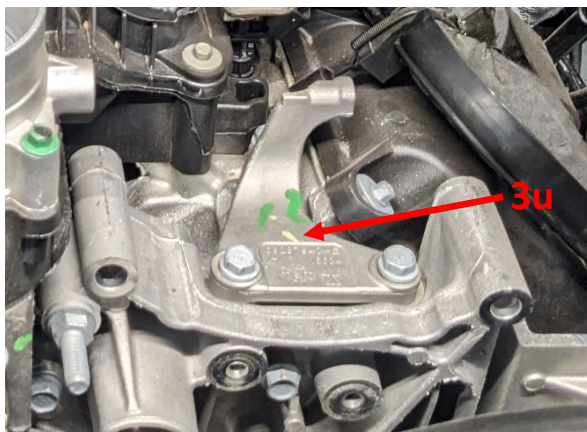

- v. Unscrew 10x manifold retaining bolts.
- w. Partially lift the front of the manifold and slide forward to un-plug the SRV loom plug that is at the centre rear of the intake manifold.
- x. Detach the plastic loom support and the heater hose support from the rear of the intake manifold.
- y. Remove OE manifold. Apply protective tape over the intake ports to prevent anything falling inside.
- z. Tape up the SRV plug to seal. This will not be reused.

4) Install Harrop Supercharger Manifold

- a. Remove the IAT sensor from the OE intake tube and install it into the RHS of the supercharger manifold.

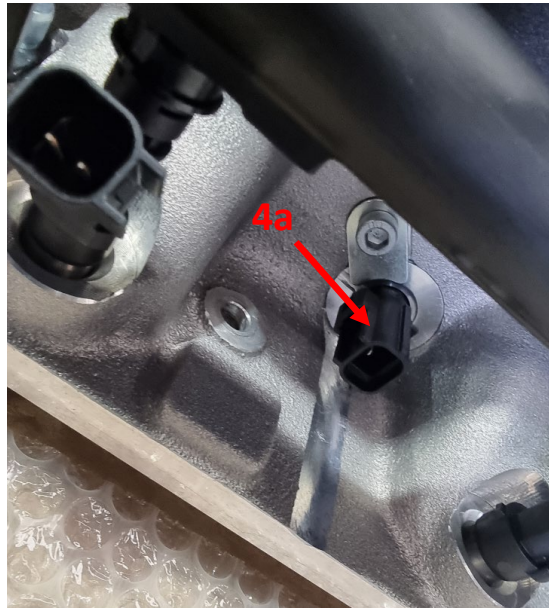

- b. To enable installation, separate the Supercharger head unit from the manifold assembly. Take note of the position of the Fuel Purge Solenoid bracket and the 2x studs on the RHS of the Supercharger.
- c. Install the supplied Map sensor extension loom to the vehicle loom at the back of the engine.
- d. Using the supplied M6x12 button head screws, install the Teflon gaskets to the supercharger manifold. Ensure there are 10X o-rings between the Teflon gasket and the manifold, 5 per side.
- e. Ensure a further 10X o-rings are installed in the Teflon gaskets to seal the head faces.
- f. Remove the protective tape applied over the ports earlier, ensuring nothing enters the intake ports.

RAM HEMI 5.7L WITH ETORQUE SUPERCHARGER



Installation Guide

- g. Install the manifold assembly to the engine. Use the 10x M6x30 flange head screws. Torque to 10-12 Nm.
- h. Fit the OE oil cap to the supercharger manifold fill tube.

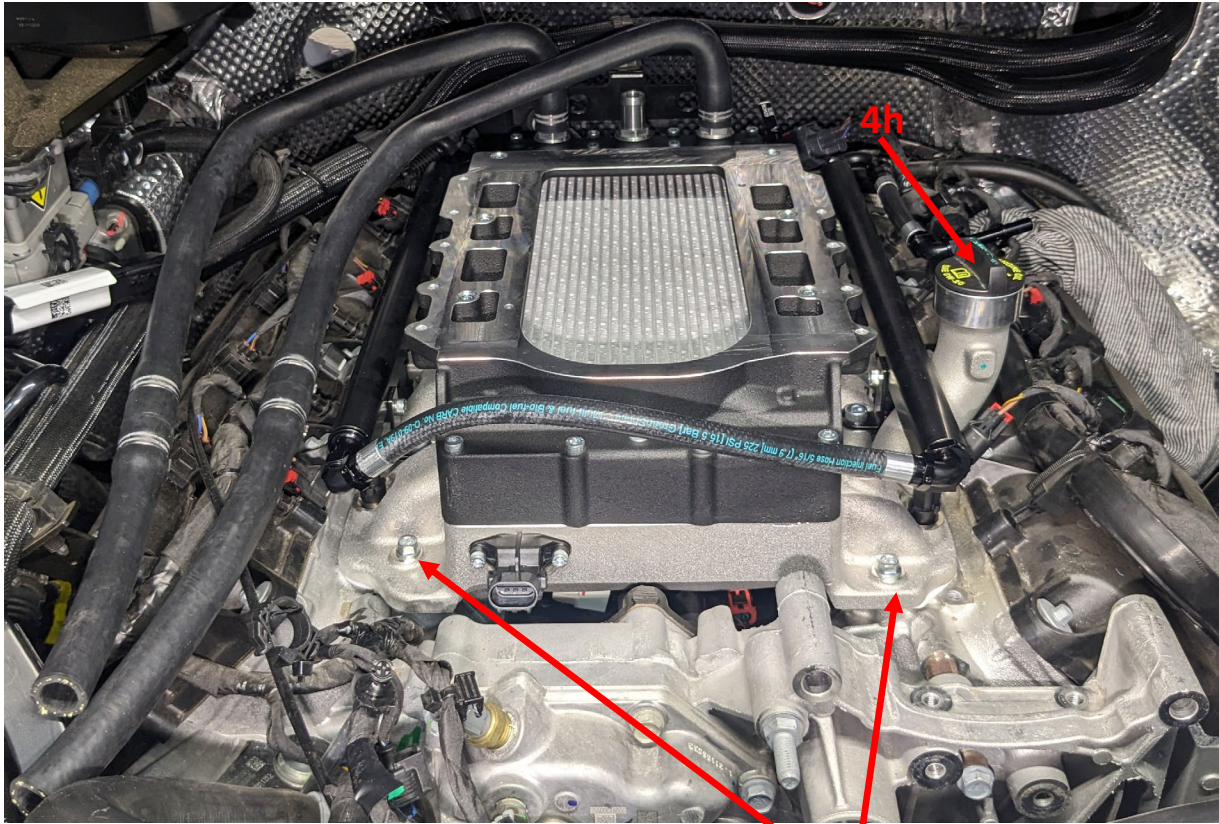

4g
10 PLACES

5) Install Ancillary hoses

- Connect the supplied 3/8" x 240 long vacuum hose to the white side of the Fuel Purge solenoid and secure with the original hose clamp.
- Connect one end of the supplied 1/2" x 600 long vacuum hose to the black side of the Fuel Purge solenoid and the other end to the hardline just beneath the fuel supply line. Secure with the supplied 18mm cobra clamps.
- Connect the supplied 3/4" PCV hose to the oil filler neck and place the free end near the airbox.

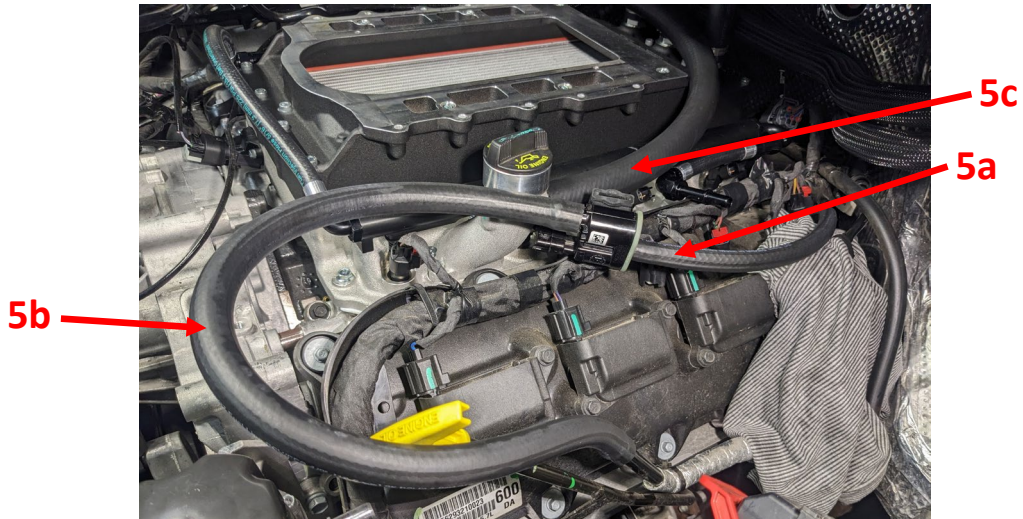

- Connect the supplied 3/8" x 380 long vacuum hose to the brake booster vacuum hard line.
- Connect brake booster vacuum line back to the vacuum pump.

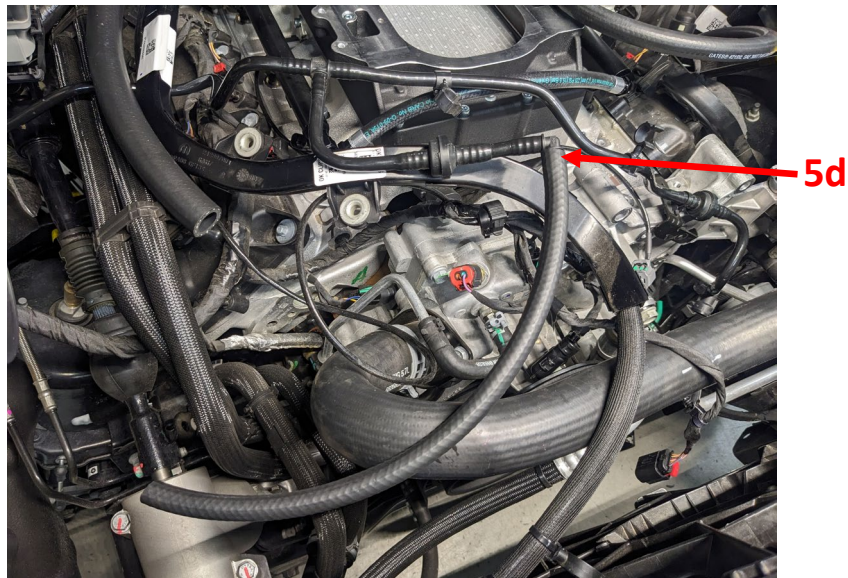

6) Wiring

- Connect the supplied IAT extension loom to the original loom and connect to the IAT sensor.
- Connect the supplied MAP extension loom to the original loom and connect to the MAP sensor.
- Connect the supplied fuel purge extension loom to the original loom and connect to the fuel purge solenoid.
- Plug the coolant temp lead back into the sensor in the original location on the front of the engine.
- Plug in the injectors.

7) Plumbing the intercooler

- Connect one end of the supplied $\frac{3}{4}$ " heater hose x 1800mm long to the centre hose barb at the rear of the supercharger manifold and secure with the supplied 23mm cobra clamp. This will run to the intercooler pump outlet.
- Run the free end of this hose behind the Brake booster (on RHD vehicles) and along the inner guard and behind the Air-box.
- Connect the 2x intercooler outlet hoses to the reservoir and install 23mm cobra clamps.
- Connect the free end of the intercooler pump outlet hose (1800mm long) to the pump. Secure with 16-24mm hose clamp. Trim to length if necessary.
- Fit moulded hose between the bottom of the intercooler radiator and the inlet of the pump, using the supplied 16-24mm hose clamps.
- Connect the 1150mm long $\frac{3}{4}$ " heater hose between the bottom port of the coolant reservoir bottle and the top port of the intercooler radiator to complete the circuit. Secure the hose at the bottom of the reservoir bottle using the supplied 26mm cobra clamp and secure at the radiator using the supplied 16-24mm hose clamp. Run the hose along the inner guard.

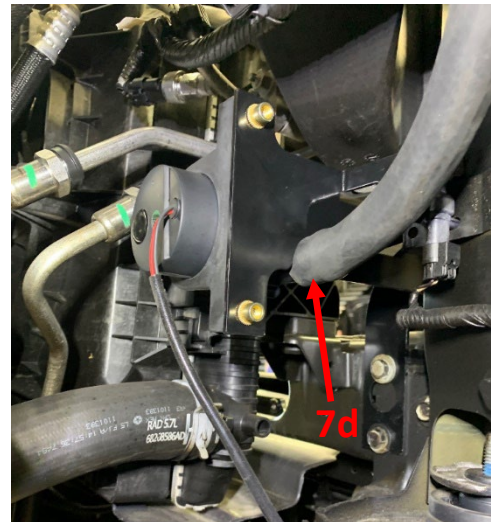
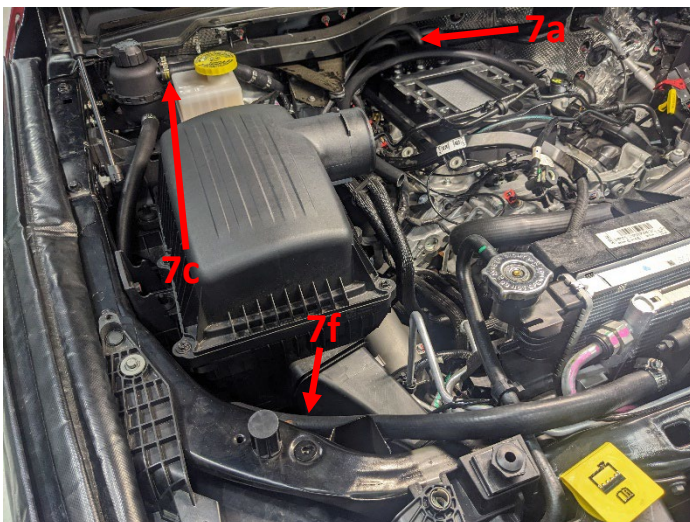

8) Install Supercharger Head Unit and Intake

- a. Install the Supercharger head unit to the manifold assembly with the supplied eTorque cable bracket in the location shown.

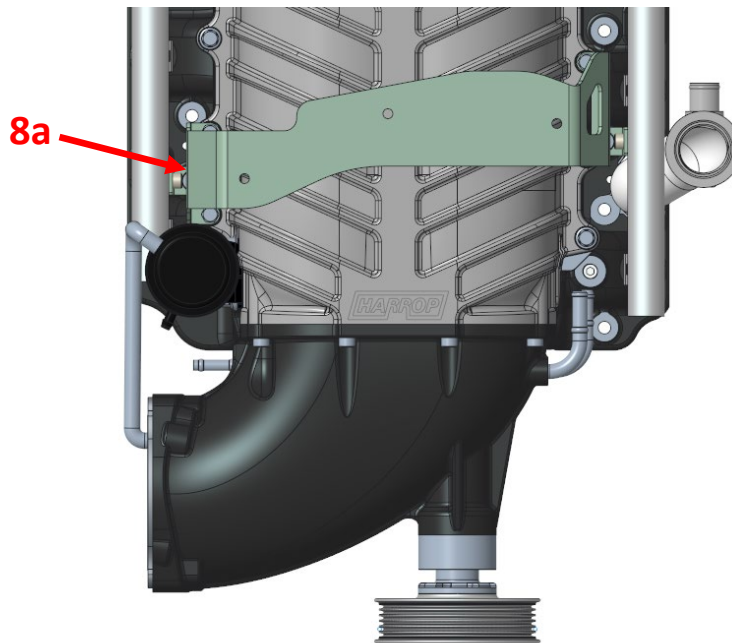

- b. Torque the screws to 18 +/-2Nm. Ensure the Fuel Purge Solenoid bracket is installed back into its original location on the side of the supercharger, and that the 2x studs are back in the same place.
- c. Mount eTorque cable to the bracket using the included M6x30 flanged bolts and the OEM nuts.
- d. Fit the fuel purge solenoid to the bracket and connect the fuel purge hose to the lower port on the LHS of the supercharger, securing with the included 13mm cobra clamp.



- e. Remove the yellow sticker from the supercharger inlet and install the supplied throttle adapter using the supplied M6 x 25 screws. Install the OE Throttle to the adapter using the supplied M6 x 40 screws. Orient the black plastic cover on the throttle to the rear of the vehicle. Make sure the O-rings are in place.
- f. Connect the supplied rubber inlet boot between the throttle and air-box. Secure with the supplied hose clamps.

- g. Attach the free end of the 3/8" vacuum hose that runs to the Brake Booster to the elbow underneath the supercharger inlet cover and secure with the supplied 13mm cobra clamp.

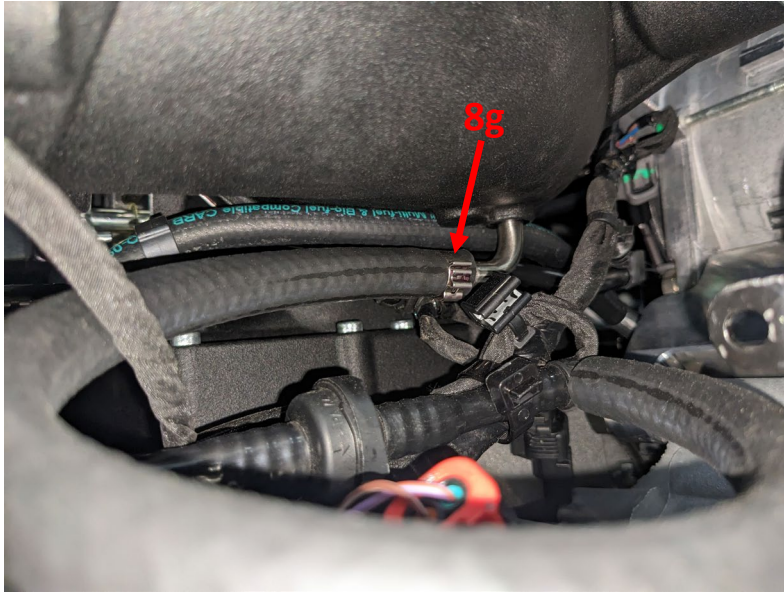

- h. Using the supplied 3/4" plastic hose joiner, connect the PCV vent hose (coming from the oil filler tube) to the inlet boot.

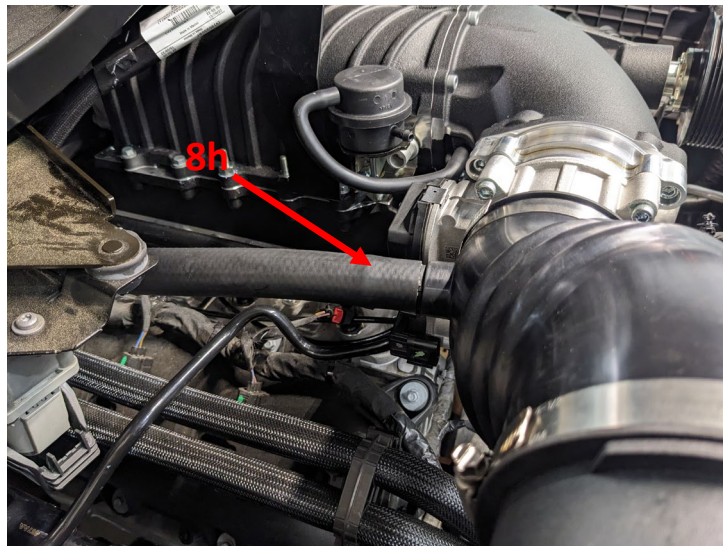

9) Install PCV housing

- Swap the PCV valve from the OE manifold to the PCV housing.
- Mount the PCV housing to the 2x studs on the RHS of the supercharger, and secure with the 2x M6 flange nuts supplied.
- Using the provided 1/2" x 400mm long PCV hose, connect the drain (bottom barb) to the Elbow on the manifold adjacent to #8 port. Trim the hose to length, ensuring it isn't kinked.
- Using the supplied 3/8" x 800 long PCV hose, connect the top barb of the PCV housing to the Top barb on the LHS of the supercharger inlet cover. Secure using supplied 13mm cobra clamps on both ends. Trim to length as required.

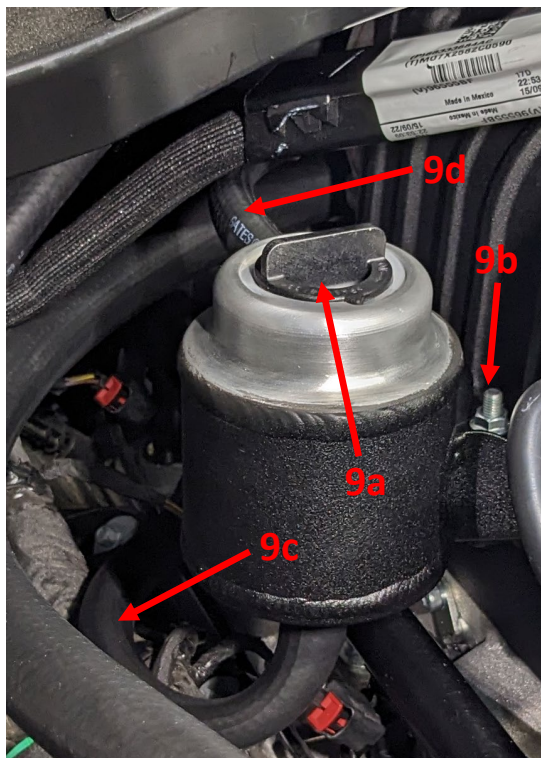

10) Install eTorque motor

- Drill the shown mounting hole to 10.5mm in diameter.
- Fit LHS mount to the eTorque motor using the OEM long bolt and OEM sliding nut.

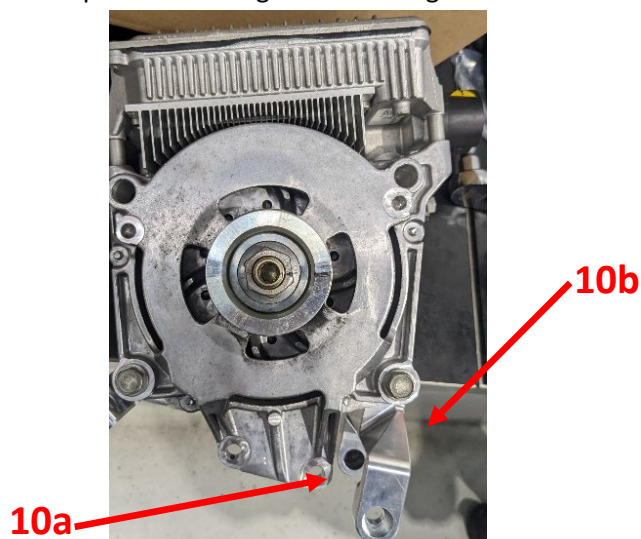

- c. Insert OEM slide nut into the RHS Etorque mount.
- d. Mount eTorque motor to original mounting location ensuring the 20mm OD spacer is between the LHS mount and the eTorque motor, using the supplied M10x130 socket head cap screw.

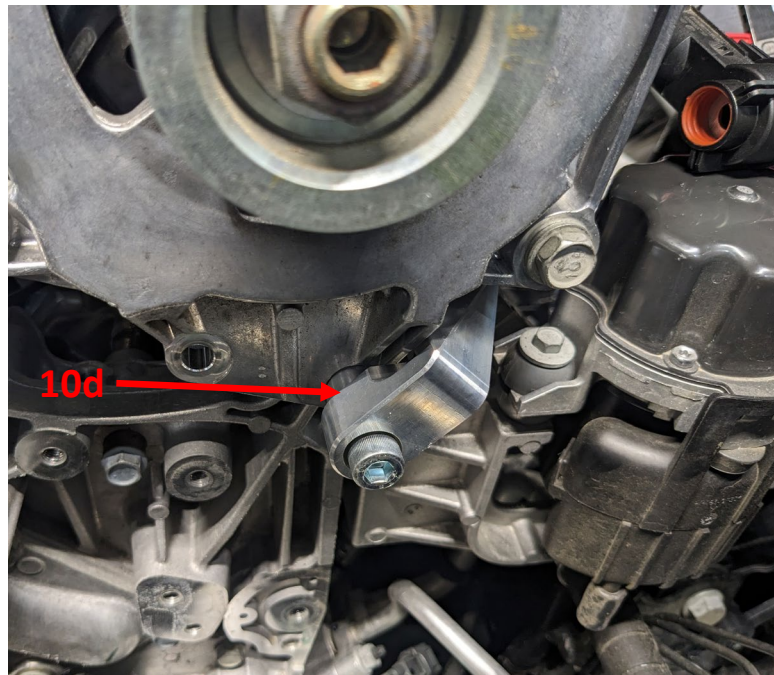

- e. Fit RHS Etorque mount to engine with the included 57mm idler, 25mm OD spacer, idler support plate, M10 washer and M10x170 bolt. Leave the bolt loose till the next step.
- f. Fit idler mount, 70mm idler, 25mm OD spacers, M10 washer and M10x170 bolt to the Etorque motor. Tighten both M10x170 bolts.

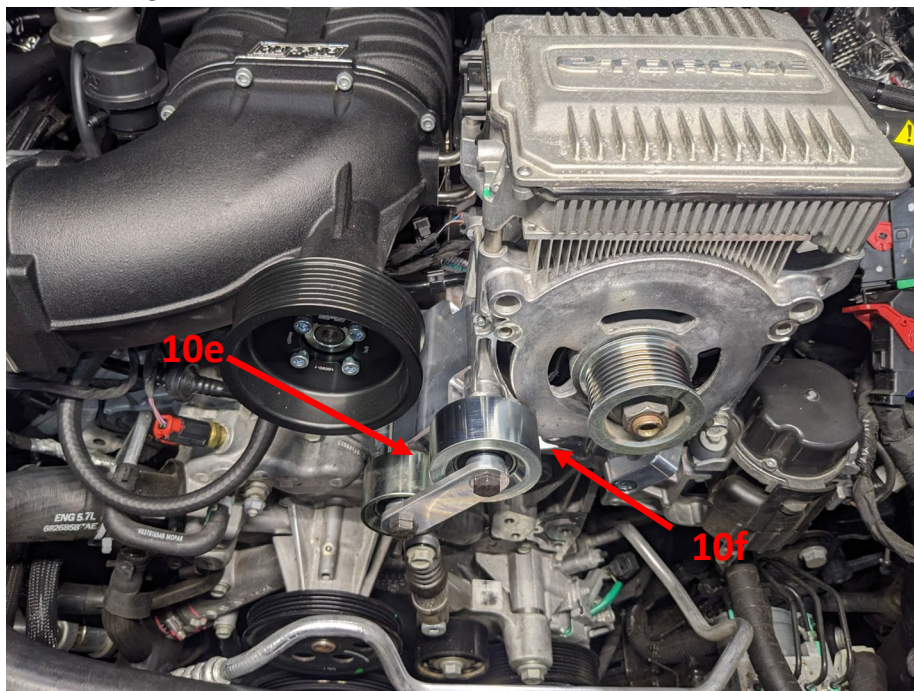

- g. Reattach the eTorque motor cable and the eTorque control harness.
- h. Reinstall the top belt tensioner.
- i. Fit the included belt on the route shown below.

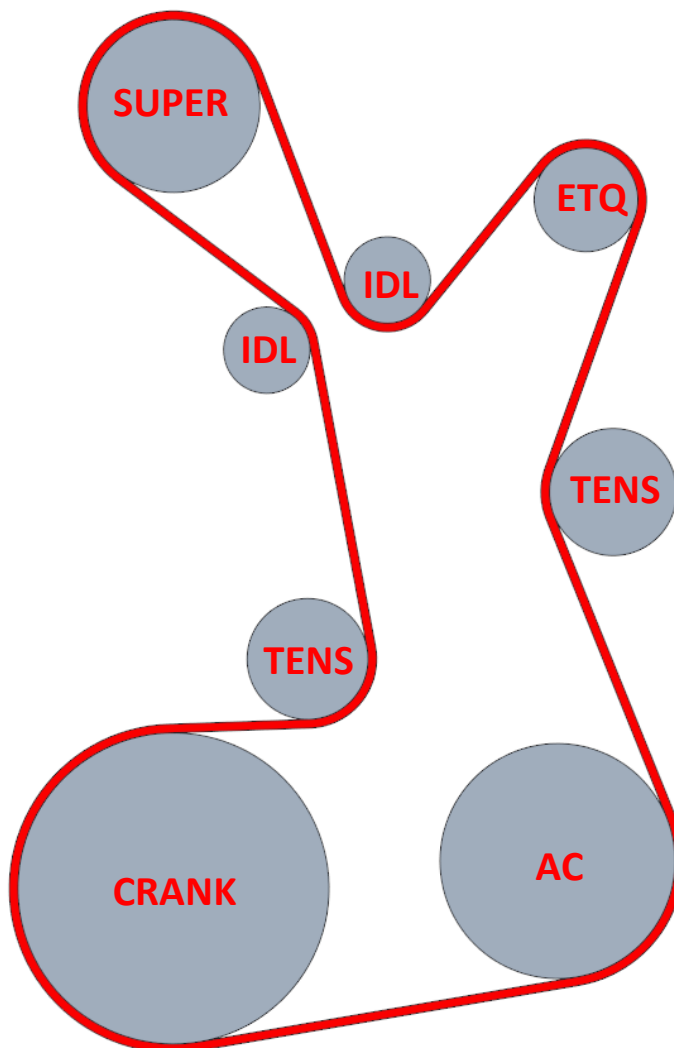

- j. Refit the lower belt tensioner stopper removed in step 3p.
- k. Reinstall the water pump belt.
- l. Refit the bracket that holds the radiator hose and the AC line at the front of the engine.
- m. Plug in throttle body harness.

11) Finalise Installation

- a. Ensure all hoses and wiring is secured and cannot come into contact with the supercharger belt, pulleys or any other moving components. Use cable ties as necessary.
- b. Fill the Intercooling system through the Reservoir. Coolant to be used is either Ford WSS-M97B44-D OR GMW3420, mixed with distilled or deionised water in a 50% concentrate.
Note filling with a noncompliant coolant will void warranty.
- c. Fill via the intercooler reservoir, allowing time for the coolant to fill down to the front mount radiator. The ideal level is 25mm below the top of the reservoir with the cap removed. Use the bleed screw on the intercooler radiator to allow air to escape during filling.
- d. Refit the ECU
- e. Re-connect Battery.
- f. Turn the ignition on without starting the engine. The intercooler pump should be running. Allow 1-2 minutes for coolant to circulate and switch the ignition off. Re-bleed the intercooler radiator and top-up the coolant level.
- g. Re-fit front grill.

12) Initial engine start and Calibration

Do not place any load or subject the engine to high speeds until ECU calibration has been performed.

It is the installer's responsibility to ensure all coolant connections are leak free, all electrical connections are sound and the proper procedures have been followed during installation.

- a. Start the engine and allow to idle only. Check that the supercharger belt is running smoothly and is correctly aligned on all pulleys.
- b. Allow the engine to reach normal operating temperature, then switch off the engine and allow to cool. Re-check the intercooler reservoir level and the engine radiator level. Check for any leaks.
- c. Calibrate the ECU for the new supercharged induction system.

13) Service considerations

The supercharged Hemi 5.7 produces significantly more power than the stock engine. Therefore, it is important to check the air filter element and spark plugs and replace, if necessary, more often than a standard vehicle. The frequency and duration of driving under high engine load, as well as environmental factors will determine how often this will be required.